

单位 Units: mm  
1 inch=25.4mm

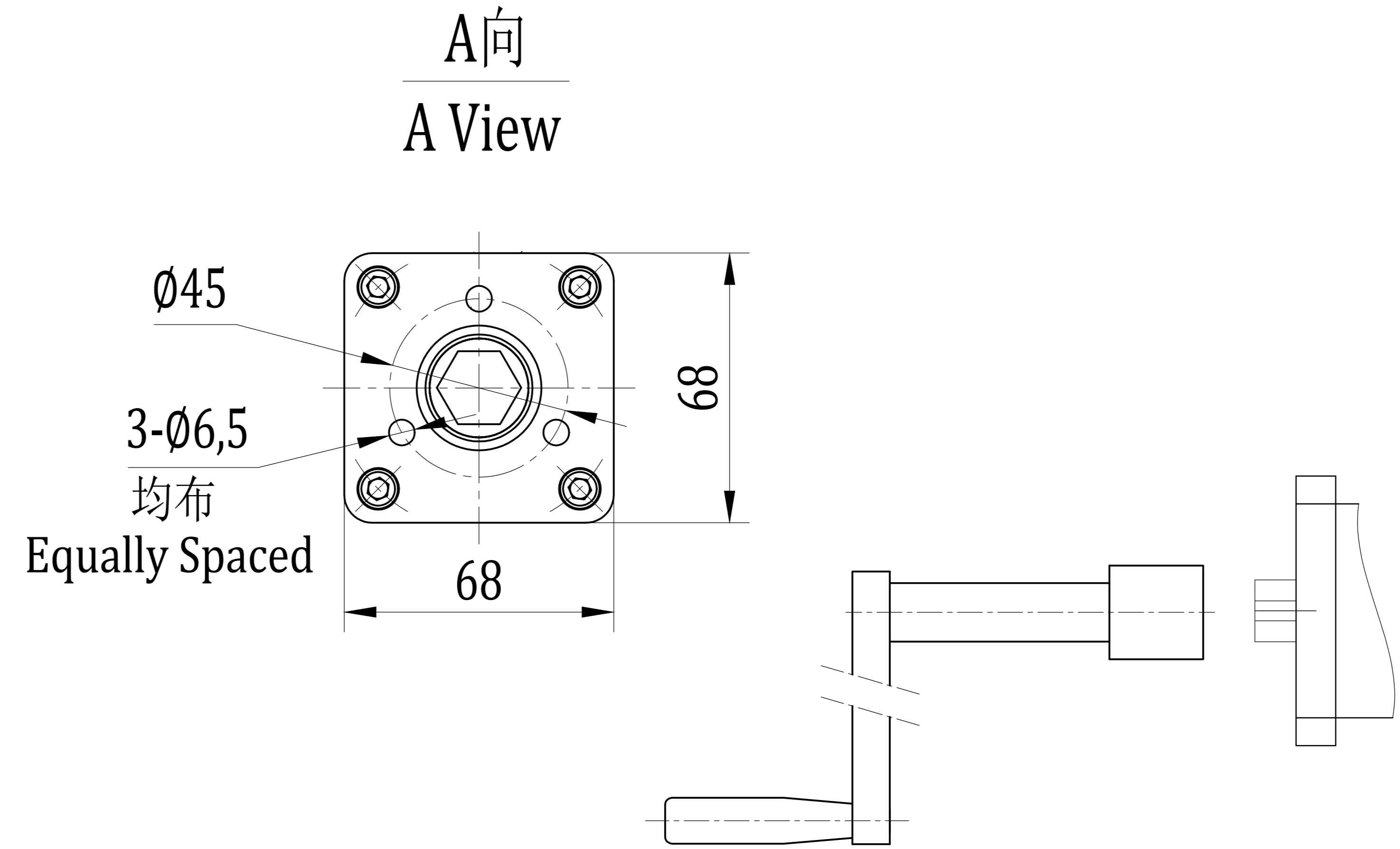

19 kg

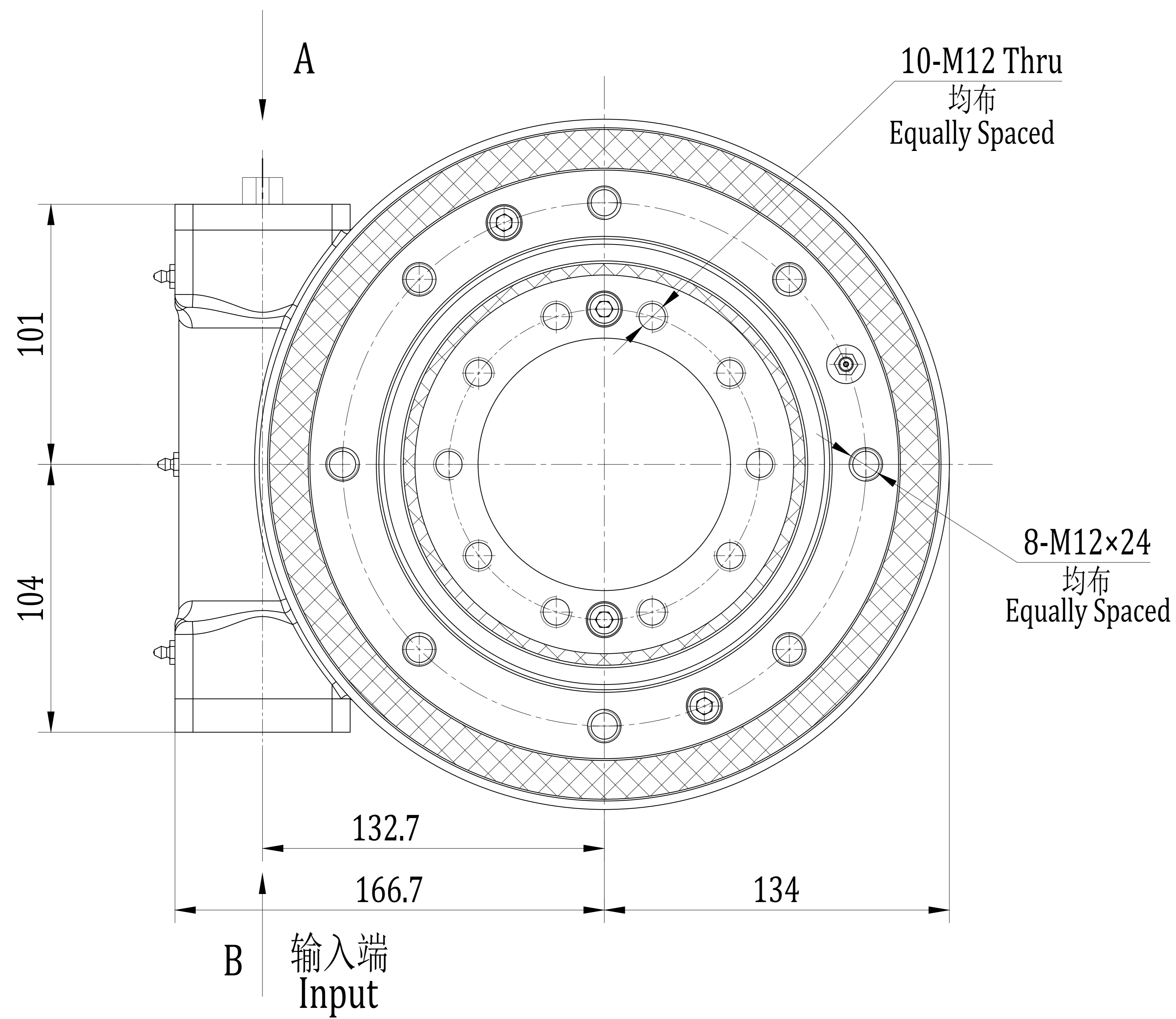
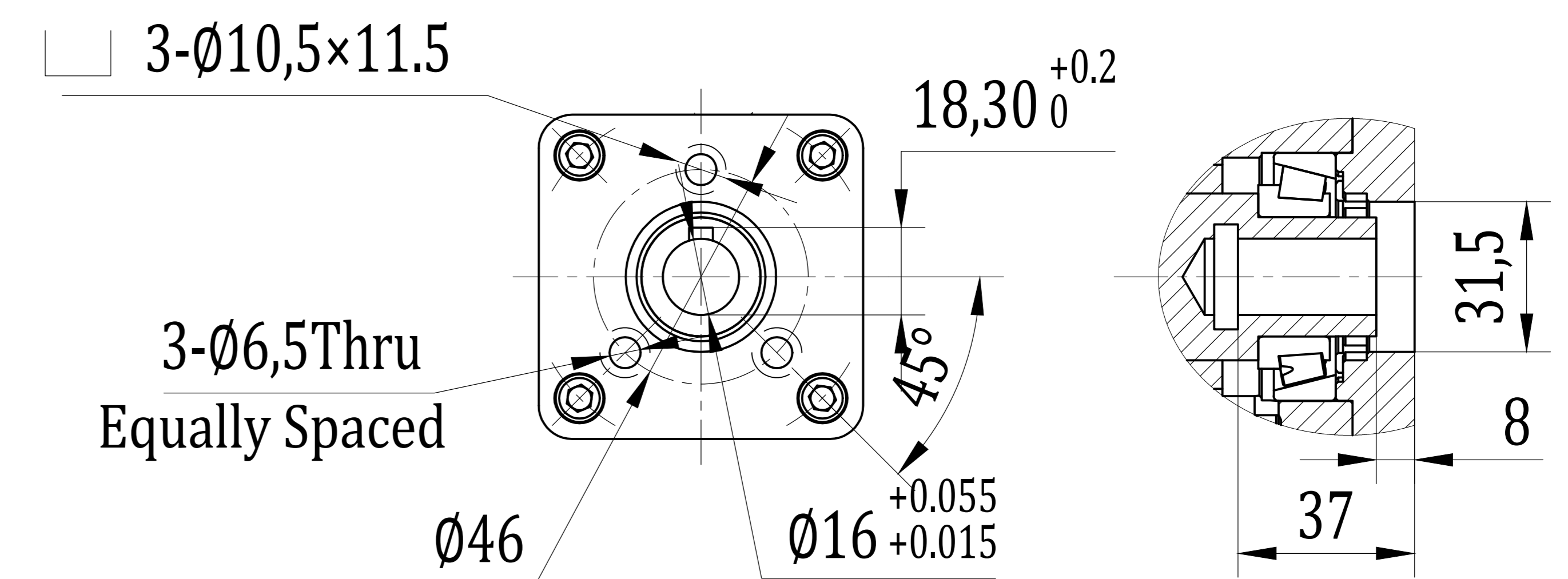
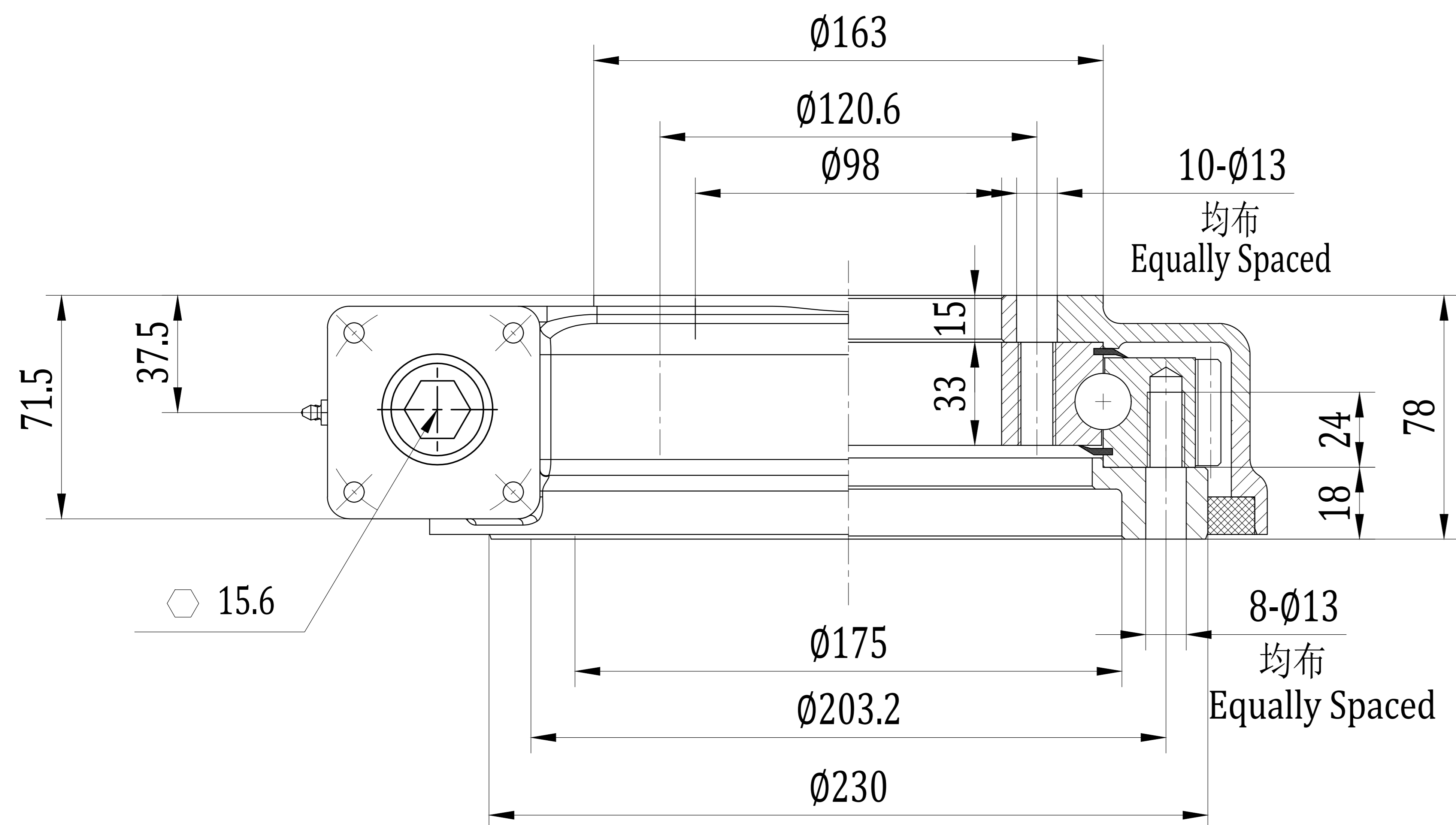

SC7

回转驱动 Slewing Drive