

单位 Units: mm  
1 inch=25.4mm

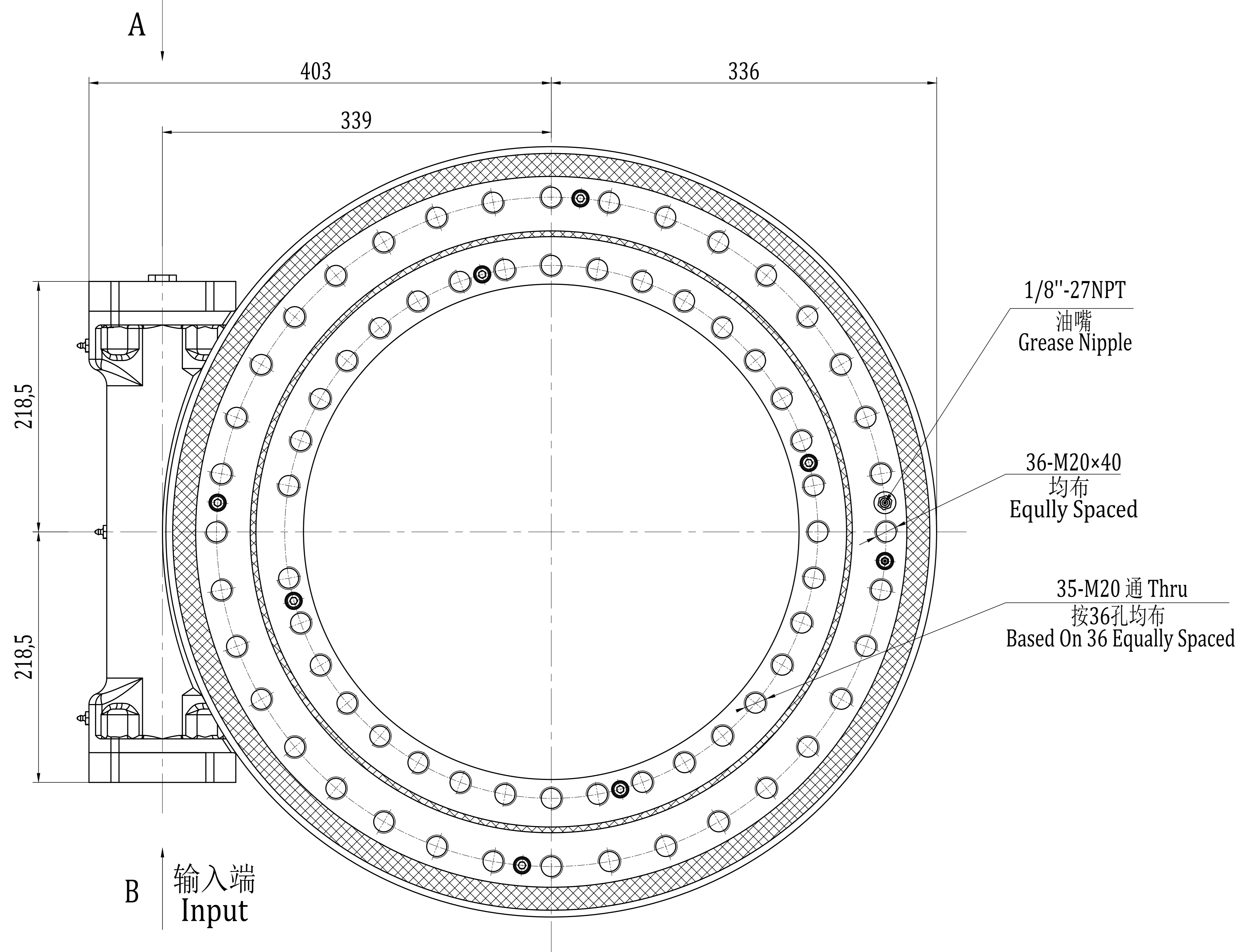

A向/A View

带六角头  
With Hex

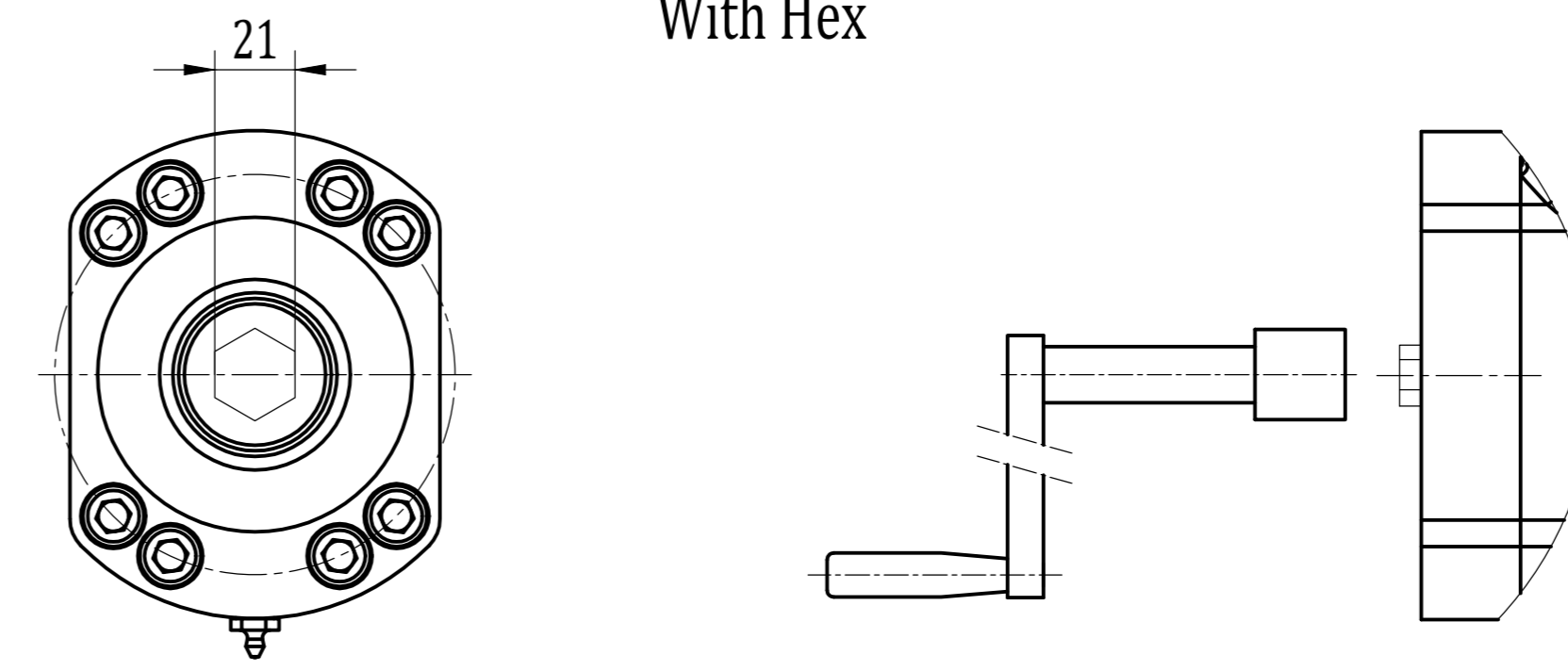

B向/B View

输入端 Input  
Ø25孔 (Ø25 Hole)

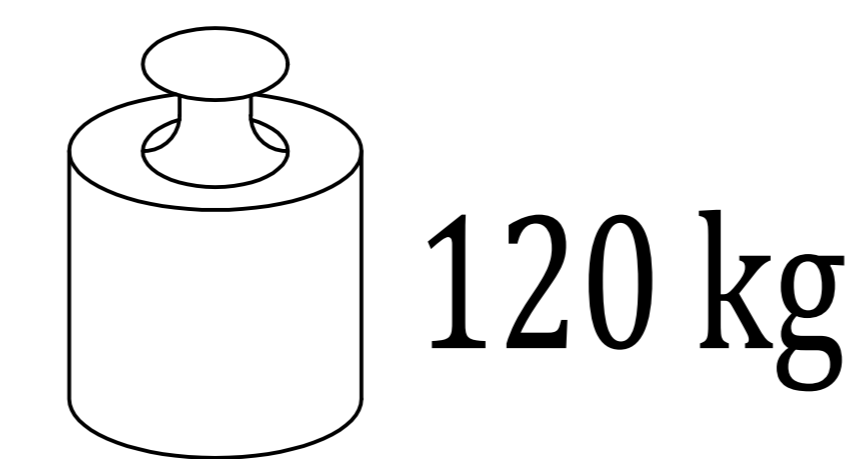
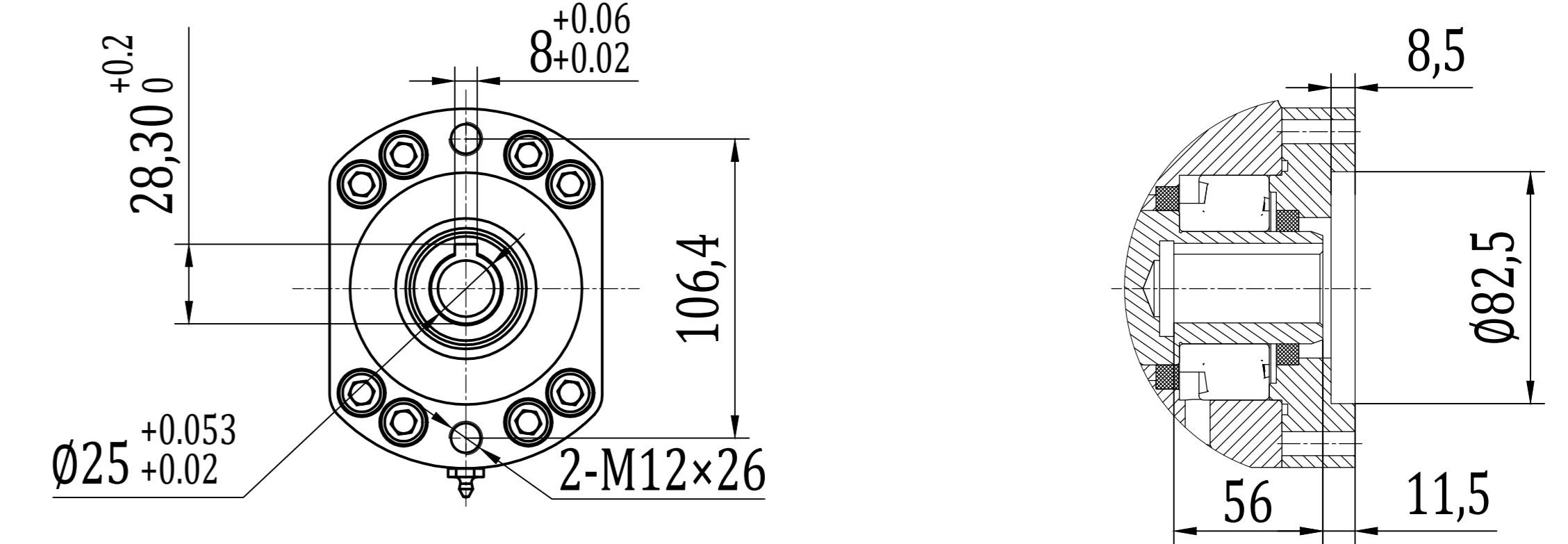

输入端 Input  
6B花键 (6B Spline)

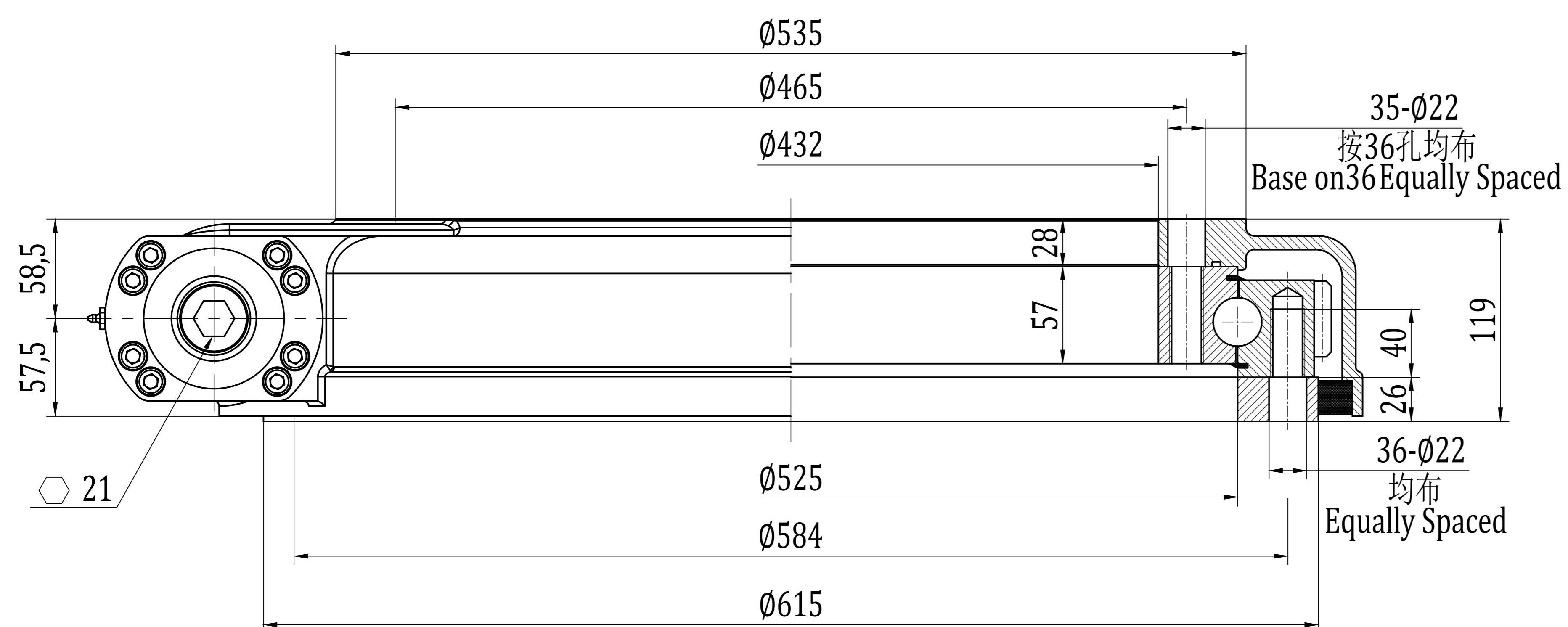
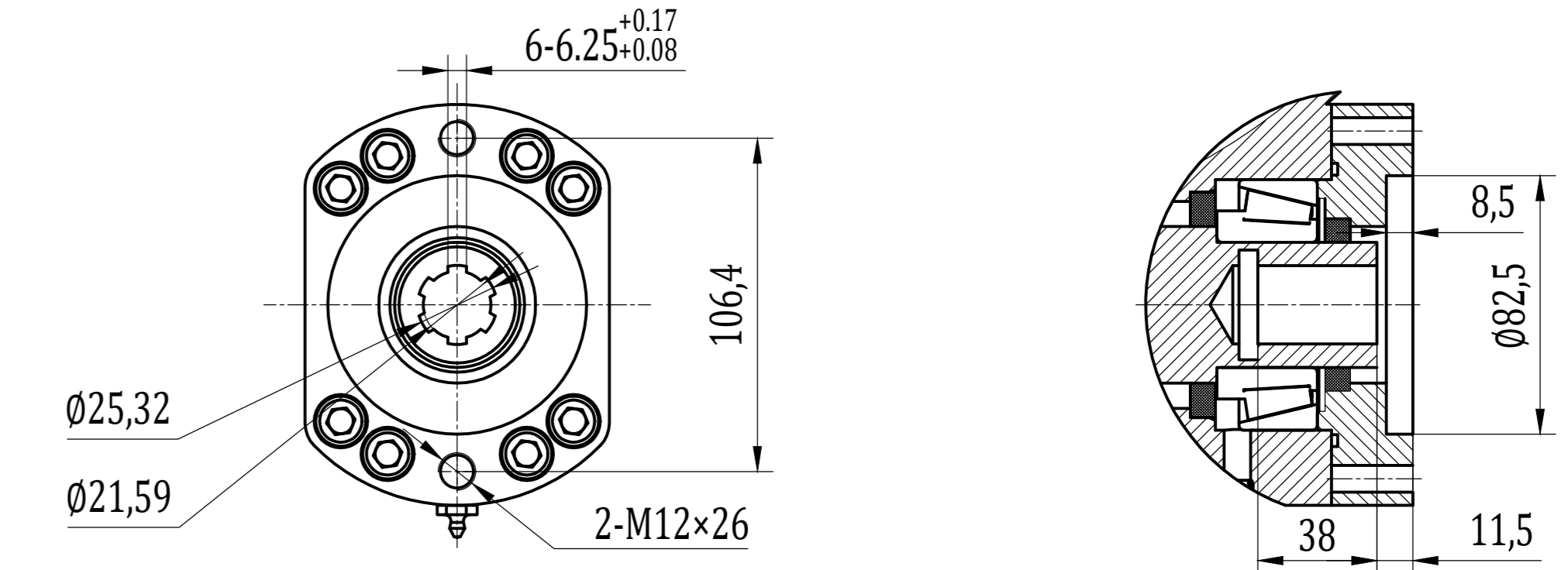

SC21

回转驱动 Slewing Drive